

THIS DOCUMENT IS THE PROPERTY OF PHAZE II PRODUCTS, INC. ANY INFORMATION, SPECS OR DESIGNS MAY NOT BE COPIED OR USED IN ANY WAY WITHOUT THE WRITTEN PERMISSION OF PHAZE II PRODUCTS AND IT MUST BE RETURNED UPON REQUEST. ANY UNAUTHORIZED USE OF THIS DOCUMENT WILL RESULT IN LEGAL ACTION AND LITIGATION.

REV	REVISIONS	DESCRIPTION	DATE	APPROVED
0	1	PRODUCTION RELEASE	12/18/07	

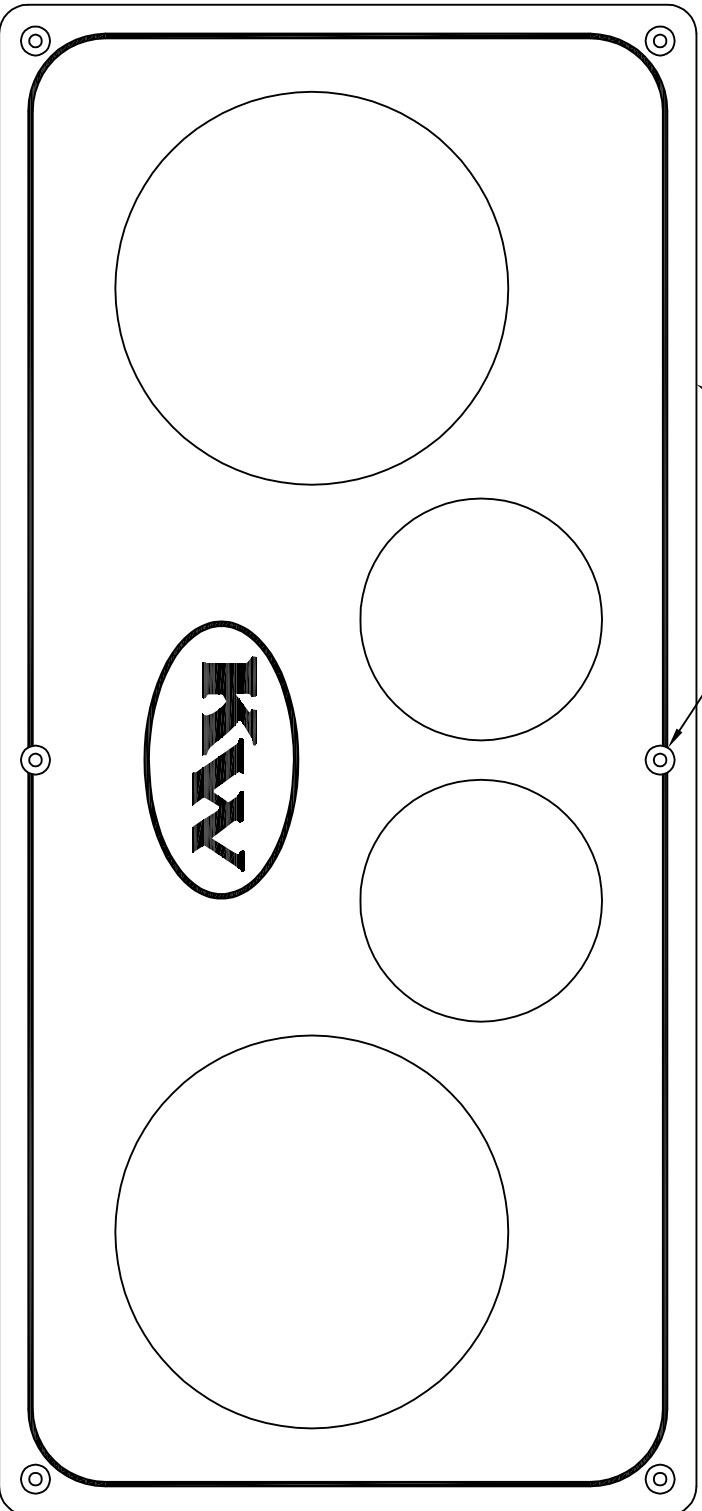

**APPROVED
RELEASED FOR
PRODUCTION USE**

ITEM NUM	QTY	DESCRIPTION OF PART	REV	PART NUMBER
1	1	TAN CARBON FUSION PANEL, .090 THK ALUMINUM	B	KWB-834HF
2	6	DOUBLE SHOULDER GROMMETT, .250 ID		112405M



118 PENNSYLVANIA
VIRGINIA BEACH, VA 23462
PHONE: 757-353-3901
FAX: 757-353-3903

PHAZE II PRODUCTS
DRN BY: LUCAS W.
CHK BY:
DATE DRAWN: 01-07-2007
SCALE: FULL
NAME: KEYWEST BOATS
2167196 STEALTH INST
PANEL ASSEMBLY
DWG NO. 14-0811
REVISION: 0

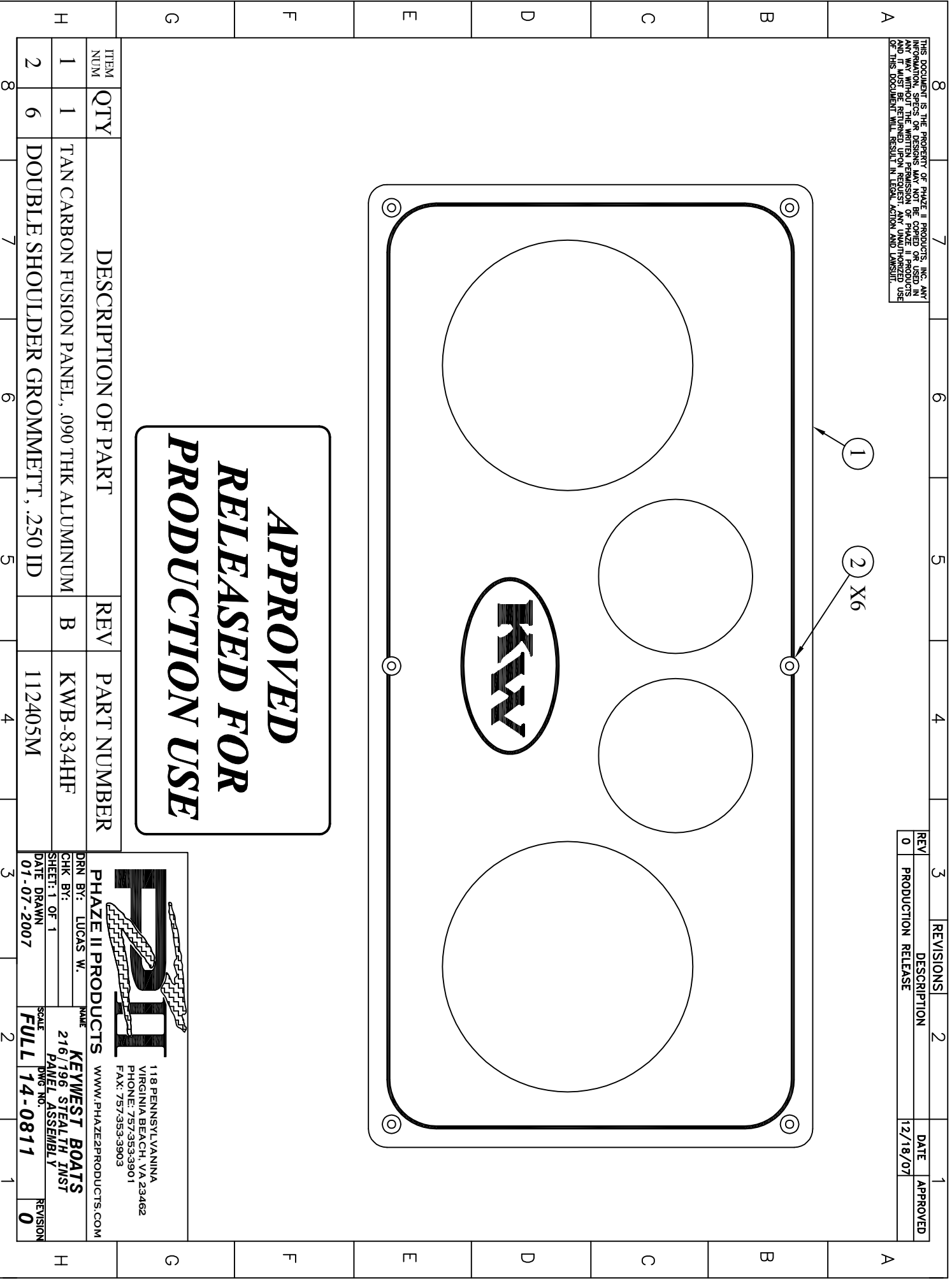

THIS DOCUMENT IS THE PROPERTY OF PHAZE II PRODUCTS, INC. ANY INFORMATION, SPECS OR DESIGNS MAY NOT BE COPIED OR USED IN ANY MANNER WITHOUT THE WRITTEN PERMISSION OF PHAZE II PRODUCTS, INC. IT MUST BE RETURNED UPON REQUEST AND UNAUTHORIZED USE OF THIS DOCUMENT WILL RESULT IN LEGAL ACTION AND LITIGATION.

REV	DESCRIPTION	DATE	APPROVED
0	PRODUCTION RELEASE	12/18/07	

**APPROVED
RELEASED FOR
PRODUCTION USE**

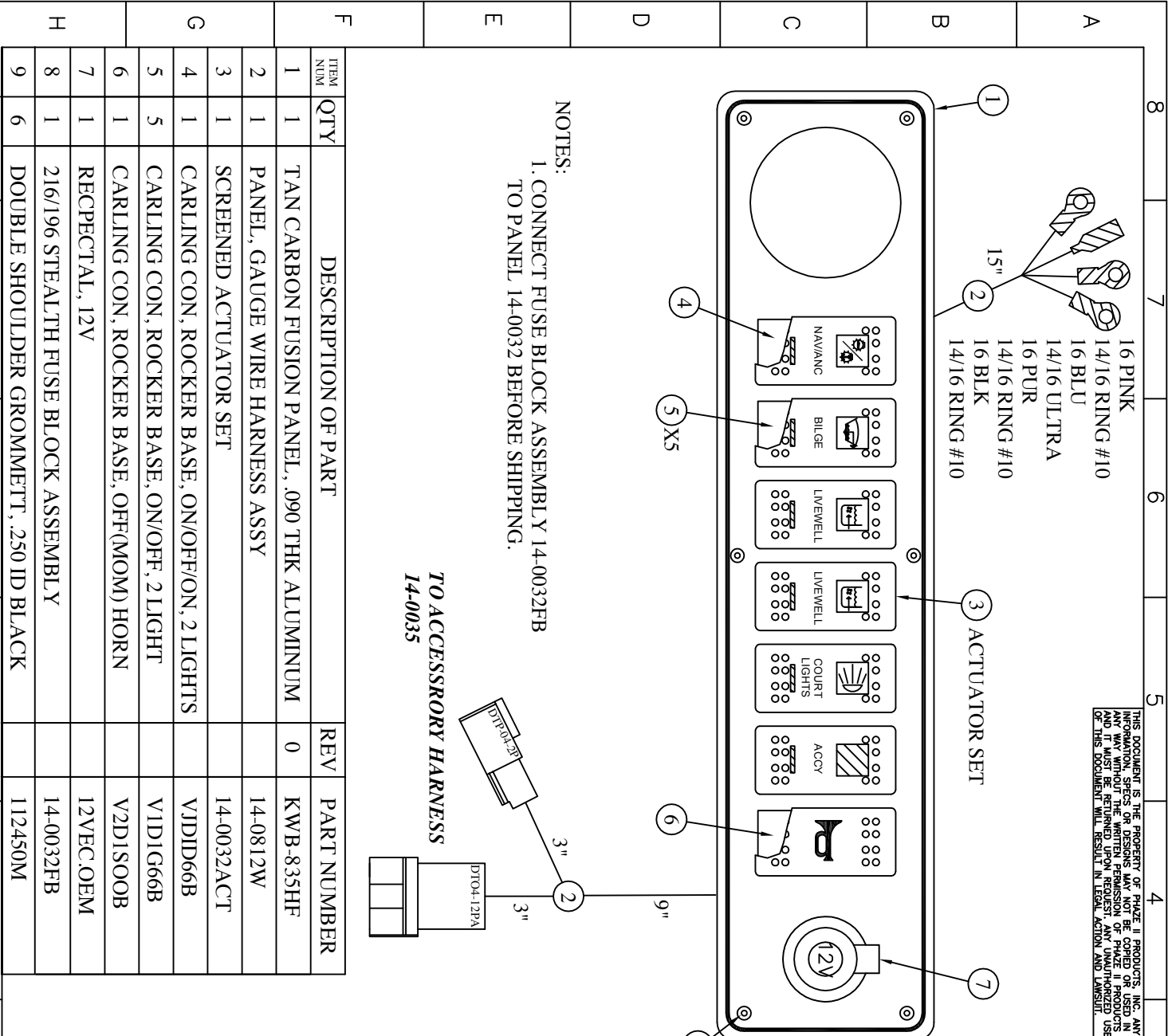

NOTES:
1. CONNECT FUSE BLOCK ASSEMBLY 14-0032FB TO PANEL 14-0032 BEFORE SHIPPING.

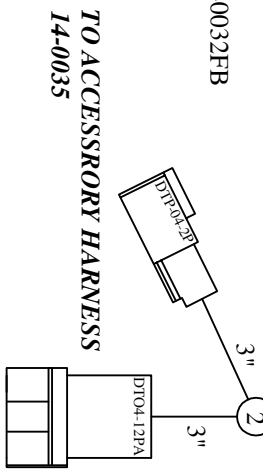

**TO ACCESSORY HARNESS
14-0035**

ITEM NUM	QTY	DESCRIPTION OF PART	REV	PART NUMBER
1	1	TAN CARBON FUSION PANEL, .090 THK ALUMINUM	0	KWB-835HF
2	1	PANEL, GAUGE WIRE HARNESS ASSY		14-0812W
3	1	SCREENED ACTUATOR SET		14-0032ACT
4	1	CARLING CON, ROCKER BASE, ON/OFF/ON, 2 LIGHTS		VJDD66B
5	5	CARLING CON, ROCKER BASE, ON/OFF, 2 LIGHT		V1D1G66B
6	1	CARLING CON, ROCKER BASE, OFF(MOM) HORN		V2D1SOOB
7	1	RECTPECTAL, 12V		12VEC.OEM
8	1	216/196 STEALTH FUSE BLOCK ASSEMBLY		14-0032FB
9	6	DOUBLE SHOULDER GROMMETT, .250 ID BLACK		112450M

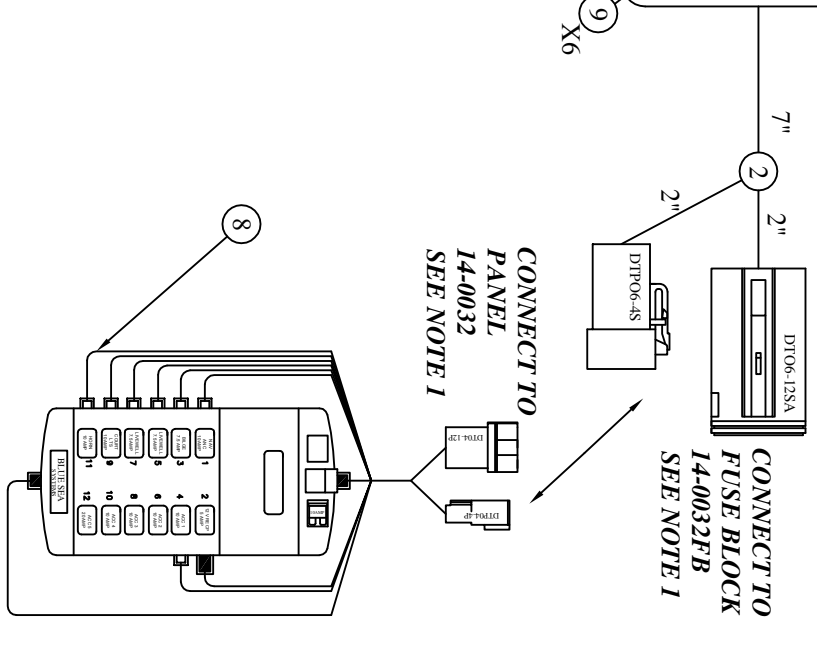

PHAZE II PRODUCTS
118 PENNSYLVANIA
VIRGINIA BEACH, VA 23462
PHONE: 757-353-3901
FAX: 757-353-3903

WWW.PHAZE2PRODUCTS.COM

DRN BY: LUCAS W.

CHK BY:

DATE DRAWN: 12-18-2007

SHEET: 1 OF 2

SCALE: FULL

DWG NO: 14-0812

REVISION: 0

KEYWEST BOATS
216/196 2008 MODEL
PANEL ASSEMBLY

8	7	6	5	4	3	2	1
12 WAY DEUTSCH PLUG CONNECTOR DETAIL DT06-12SA		4 WAY DEUTSCH CONNECTOR DTPO6-4S		REV		REVISIONS	DATE
WIRE LOAD VIEW DT06-12SA		WIRE LOAD VIEW		0		2	12/18/07
1. 16 GA GRAY 2. HOLE PLUG 114017 3. 16 GA ORANGE/WHITE 4. 16 GA BLUE/WHITE 5. 16 GA BROWN/ORANGE 6. 16 GA BROWN/GREEN		1. 10 GA RED 2. 10 GA RED/WHITE 3. 10 GA BLACK 4. HOLE PLUG 114017		PRODUCTION RELEASE		APPROVED	

THIS DOCUMENT IS THE PROPERTY OF PHAZE II PRODUCTS, INC. ANY INFORMATION, SPECS OR DESIGNS MAY NOT BE COPIED OR USED IN ANY WAY WITHOUT THE WRITTEN PERMISSION OF PHAZE II PRODUCTS AND IT MUST BE RETURNED UPON REQUEST. ANY UNAUTHORIZED USE OF THIS DOCUMENT WILL RESULT IN LEGAL ACTION AND LANSUIT.

**APPROVED
RELEASED FOR
PRODUCTION USE**

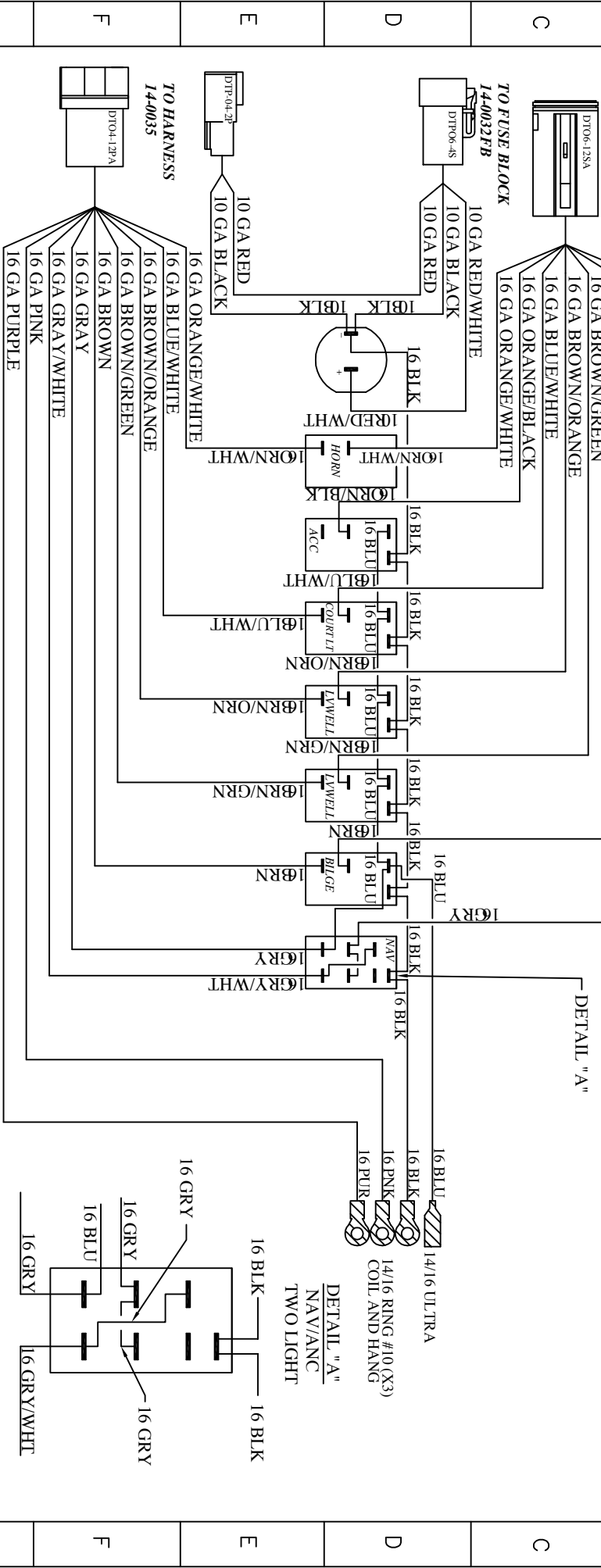

12 WAY DEUTSCH RECP CONNECTOR DETAIL DT04-012PA

WIRE LOAD VIEW DT04-12PA

1. 16 GA GRAY
2. 16 GA ORANGE/WHITE
3. 16 GA ORANGE/WHITE
4. 16 GA BLUE/WHITE
5. 16 GA BROWN/ORANGE
6. 16 GA BROWN/GREEN

2 WAY DEUTSCH CONNECTOR DETAIL DTPO4-2P

WIRE LOAD VIEW

1. 10 GA RED
2. 10 GA BLACK

PHAZE II PRODUCTS
118 PENNSYLVANIA VIRGINIA BEACH, VA 23462
PHONE: 757-353-3901 FAX: 757-353-3903
WWW.PHAZE2PRODUCTS.COM

KEYWEST BOATS
218/196 2008 MODEL
PANEL WIRING DIAGRAM
SCALE FULL DWG NO. 14-0812

DRN BY: LUCAS W.
CHK BY: 2 OF 2
SHEET: 2 OF 2
DATE DRAWN 12-18-2007

REVISION 0

**APPROVED
RELEASED FOR
PRODUCTION USE**

THIS DOCUMENT IS THE PROPERTY OF PHAZE II PRODUCTS, INC. ANY INFORMATION, SPECS OR DESIGNS MAY NOT BE COPIED OR USED IN ANY WAY WITHOUT THE WRITTEN PERMISSION OF PHAZE II PRODUCTS. AND IT MUST BE RETURNED UPON REQUEST. ANY UNAUTHORIZED USE OF THIS DOCUMENT WILL RESULT IN LEGAL ACTION AND LITIGATION.

PLUG "A", 12 WAY, 14/16 GA, DEUTSCH PLUG CONNECTOR DETAIL W/ RECEP DT06-12SA

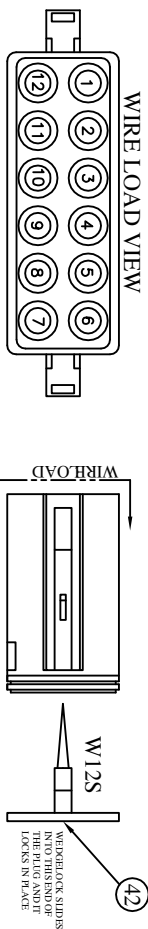

1. 16 GA GRAY
2. 16 GA GRAY/WHITE
3. 16 GA ORANGE/WHITE
4. 16 GA BLUE/WHITE
5. 16 GA BROWN/ORANGE
6. 16 GA BROWN/GREEN
7. 16 GA BROWN
8. 16 GA PINK
9. 16 GA PURPLE
10. HOLE PLUG 114017
11. HOLE PLUG 114017
12. HOLE PLUG 114017

PLUG "B", 2 WAY, 10/12 GA DEUTSCH PLUG CONNECTOR DETAIL W/ RECEP DT06-2S

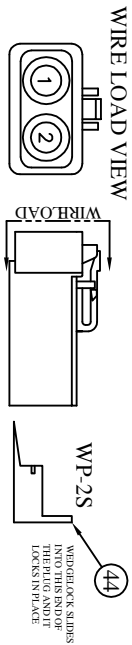

1. 10 GA RED
2. 10 GA BLACK

PLUG "C", 2 WAY, 14/16 GA DEUTSCH PLUG CONNECTOR DETAIL W/ RECEP DT06-2S

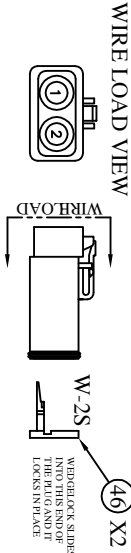

1. 16 GA BROWN/ORANGE
2. 16 GA BLACK

PLUG "D", 2 WAY, 14/16 GA DEUTSCH PLUG CONNECTOR DETAIL W/ RECEP DT06-2S

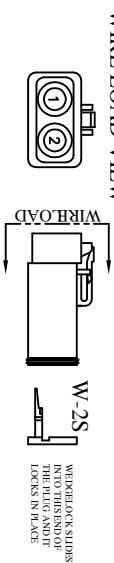

1. 16 GA BROWN/GREEN
2. 16 GA BLACK

PLUG "E", 3 WAY, 14/16 GA DEUTSCH PLUG CONNECTOR W/RECP DETAIL DT06-3S

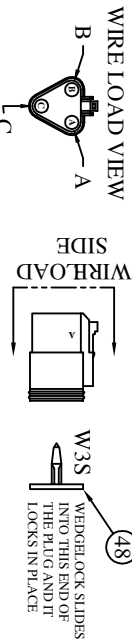

- 16 GA BROWN
- 16 GA BROWN/RED
- 16 GA BLACK

REV	DESCRIPTION	DATE	APPROVED
0	PRODUCTION RELEASE	8/07/06	
A	ADDED SPECS TO BILGE AND LIVEWELLS	11/07/06	

FUSE COVER DETAIL "F"

**APPROVED
RELEASED FOR
PRODUCTION USE**

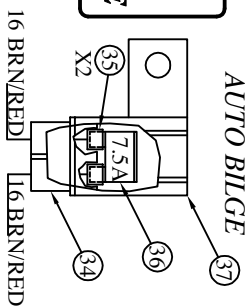

30AMP SURFACEMOUNT BREAKER DETAIL "G"
INSTALL TWO SMALL RED BOOTS(4702)
ON 10 GA REDS ON 30 AMP BREAKER

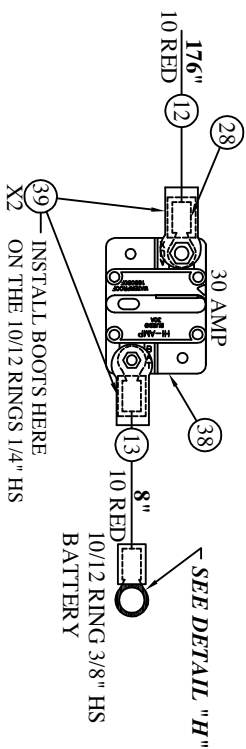

LARGE RED BATTERY BOOT DETAIL "H"

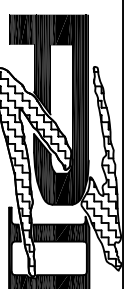
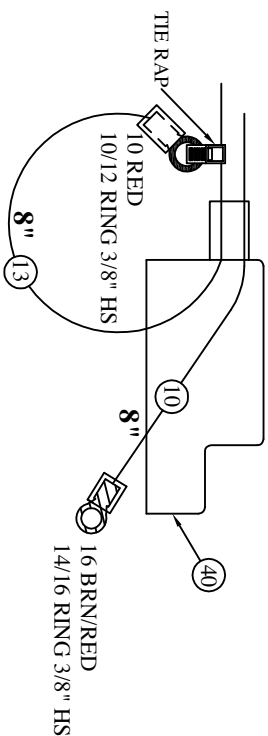

118 PENNSYLVANIA
VIRGINIA BEACH, VA 23462
PHONE: 757-353-3901
FAX: 757-353-3903

PHAZE II PRODUCTS WWW.PHAZE2PRODUCTS.COM

DRN BY: LUCAS W. NAME: KEYWEST BOATS
CHK BY: 216/196 STEALTH ACC HARNESS
SHEET: 2 OF 4 PLUGGING, FUSE COVER, BREAKER
DATE DRAWN: 11-07-2006 AND BATTERY BOOT DETAILS
SCALE: FULL 14-0035
REVISION: A

A	8	7	6	5	4	3	2	1
B	8	7	6	5	4	3	2	1
C	8	7	6	5	4	3	2	1
D	8	7	6	5	4	3	2	1
E	8	7	6	5	4	3	2	1
F	8	7	6	5	4	3	2	1
G	8	7	6	5	4	3	2	1
H	8	7	6	5	4	3	2	1

ALL PLUG DETAILS ON PAGE 2 DO NOT PRODUCE PRODUCTION PARTS FROM DRAWINGS THAT ARE MARKED "PROTOTYPE"

REV	DESCRIPTION	DATE	APPROVED
0	PRODUCTION RELEASE	8-07-05	
1	ADDED SPLIT TUBE TO BILGE AND LIVEWELLS	11/07/06	

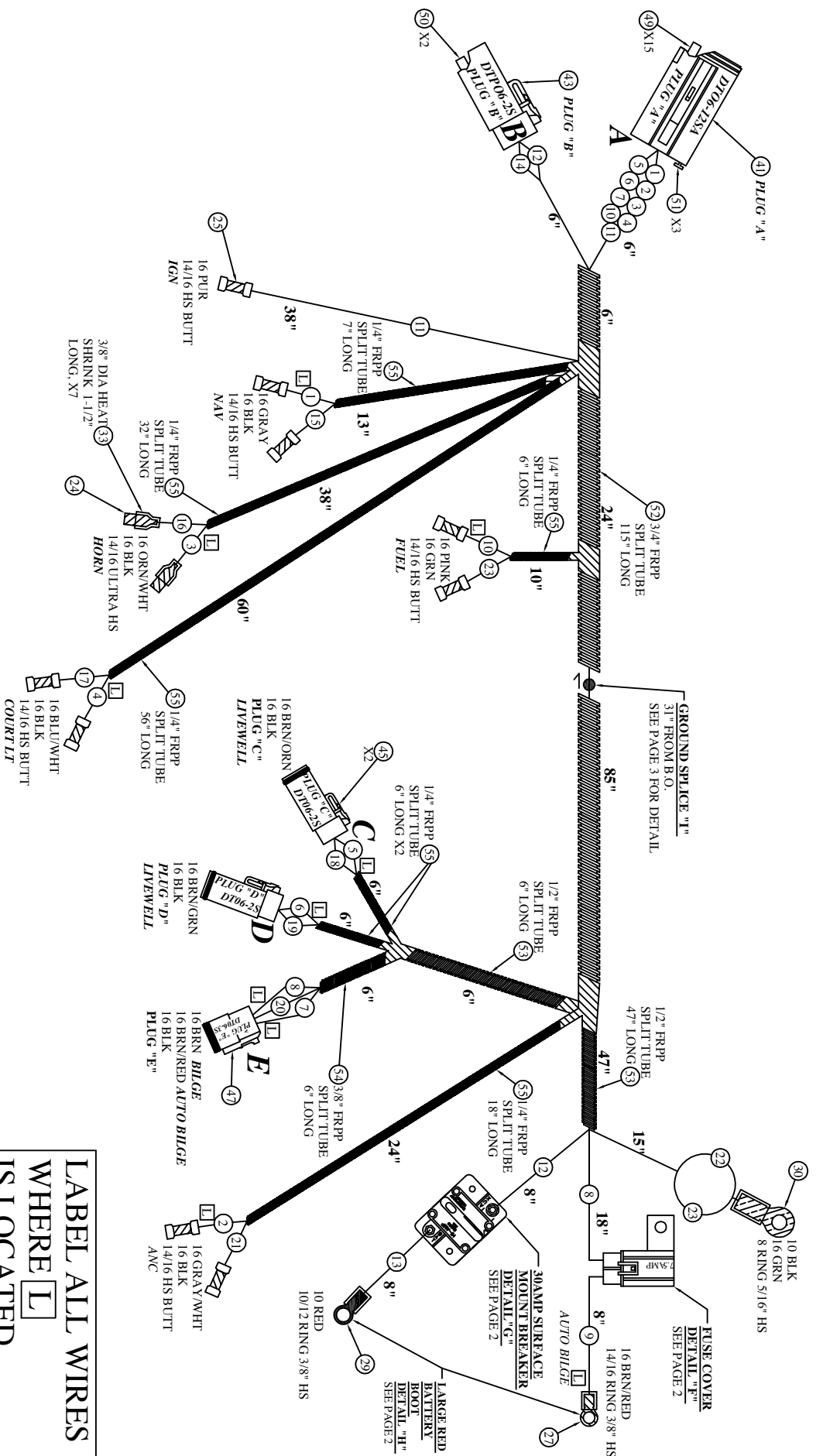

TERMINAL CHART

	14/16 ULTRA HS = 2
	14/16 HS BUTT = 9
	14/16 RING TERMINAL 3/8" HS = 1
	10/12 RING TERMINAL 1/4" HS = 2
	10/12 RING TERMINAL 3/8" HS = 1
	8 RING TERMINAL 5/16" HS = 1

**APPROVED
RELEASED FOR
PRODUCTION USE**

PHAZE II PRODUCTS
 118 PENNSYLVANIA
 VIRGINIA BEACH, VA 23462
 PHONE: 757-353-3901
 FAX: 757-353-3903
 WWW.PHAZE2PRODUCTS.COM

**LABEL ALL WIRES
WHERE L
IS LOCATED**

THIS DOCUMENT IS THE PROPERTY OF PHAZE II PRODUCTS, INC. ANY INFORMATION, SPECIFICATIONS, OR DESIGNS MAY NOT BE COPIED OR USED IN ANY MANNER WITHOUT THE WRITTEN PERMISSION OF PHAZE II PRODUCTS, INC. AND IT MUST BE RETURNED UPON REQUEST. ANY UNAUTHORIZED USE OF THIS DOCUMENT WILL RESULT IN LEGAL ACTION AND LITIGATION.

DRN BY: LUCAS W.
 SHEET: 4 OF 4
 DATE DRAWN: 11-07-2006
 SCALE: FULL
 DWG NO: 14-0035